

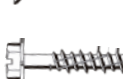







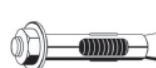

PIJAS

	FIJADORA COMBO.....1
	GALVANIZADA PUNTA AB.....1
	PLANA GALVANIZADA PUNTA AB.....2
	TABLAROCA CUERDA FINA...2
	PARA MADERA CON ARISTAS.....2
	PARA MADERA/ YESO MULTIUSOS.....2
	K-LATH PUNTA AGUDA.....3
	K-LATH PUNTA BROCA.....3
	HEXAGONAL GALVANIZADA PUNTA BROCA.....3
	PUNTA BROCA CON RONDANA EPDM.....3

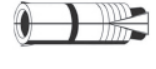

TORNILLOS ANCLA PARA CONCRETO

	CABEZA PLANA PUNTA PHILLIPS.....4
	CONCRETO CABEZA HEXAGONAL.....4

ANCLAS Y TAQUETES

	ANCLA CAMISA ACERO INOXIDABLE.....5
	ANCLA ARPÓN ACERO INOXIDABLE.....5
	TAQUETE PARA TABLAROCA.....6
	ANCLA ROSCADA PARA MURO FALSO.....6
	TAQUETE EXPANSOR.....6
	TAQUETE EXPANSOR.....6
	TAQUETE DE GOLPE.....6
	PUNZÓN PARA TAQUETE.....6

ANCLAS Y TAQUETES

	ANCLA CAMISA.....6
	ANCLA ARPÓN.....7



FIJACIÓN EN NYLON

	TAQUETES.....8
	TAQUETE PARA TABLAROCA.....8
	GRAPAS DE NYLON.....8
	ABRAZADERAS.....8
	CINCHOS DE NYLON.....8

CHAVETAS

	CHAVETAS.....9
-------------------------------------------------------------------------------------	----------------





REMACHES TOLEDO

	ACERO INOXIDABLE.....10
	ALA ESTANDAR.....10
	ALA ANCHA.....10







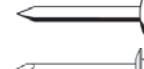
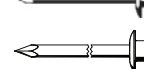

TUERCAS REMACHABLES

	ZINCADA.....10
-------------------------------------------------------------------------------------	----------------



REMACHES INDUS

	ALA ESTANDAR -11 CAJA
	ALA ANCHA -11 CAJA
	ALA ESTANDAR -11 BOLSA
	ALA ANCHA -11 BOLSA
	DE COLOR.....12

REMACHES INDUS

	MULTIAGARRE.....12
	DE CLAVO SELLADO..12
	ACERO - ACERO.....12
	TRÉBOL ALUMINIO....12
	ESTRUCTURAL.....13
	DE GOLPE CARROCERO.....13
	REMACHE DE EXPANSIÓN.....14
	REMACHE PARA BALATA.....14
	REMACHES PARA CLUTCH.....14
	POSTES DE ALUMINIO.....14



GRASERAS INDUS

	ESTANDAR.....15
	MÉTRICAS.....15





OJILLOS PARA LONAS

15
---------------------------------------------------------------------------------------	---------

ANILLOS DE RETENCIÓN

	INTERNOS.....16
	EXTERNOS.....16
	TIPO E.....17

ABRAZADERAS

	LIBERTY.....19
	HS.....19
	TRABAJO PESADO.....20
	TRABAJO PESADO CON RESORTE.....20
	PARA BOTA DE TRANSMISIÓN...21

CLAVE	DESCRIPCIÓN	PRECIO POR PIEZA	E
PIJA FIJADORA COMBO GALVANIZADA PUNTA AB			
PF06009	#6 X 3/8	\$0.140	2500
PF06013	#6 X 1/2	\$0.180	2000
PF06016	#6 X 5/8	\$0.120	1000
PF06019	#6 X 3/4.	\$0.170	1000
PF06025	#6 X 1".	\$0.370	500

PF08013	#8 X 1/2	\$0.310	1000
PF08016	#8 X 5/8.	\$0.190	500
PF08019	#8 X 3/4.	\$0.260	500
PF08025	#8 X 1".	\$0.340	500
PF08032	#8 X 1.1/4.	\$0.500	250
PF08038	#8 X 1.1/2	\$0.380	250

PF10013	#10 X 1/2.	\$0.230	500
PF10016	#10 X 5/8.	\$0.230	500
PF10019	#10 X 3/4.	\$0.440	500
PF10025	#10 X 1".	\$0.300	250
PF10032	#10 X 1.1/4	\$0.480	250
PF10038	#10 X 1.1/2.	\$0.620	250
PF10051	#10 X 2".	\$0.650	200

CLAVE	DESCRIPCIÓN	PRECIO POR PIEZA	E
PIJA PLANA GALVANIZADA PUNTA AB			
PP06009	#6 X 3/8	\$0.090	2500
PP06013	#6 X 1/2	\$0.120	2500
PP06016	#6 X 5/8	\$0.170	2000
PP06019	#6 X 3/4.	\$0.130	1500
PP06025	#6 X 1".	\$0.170	1000
PP06038	#6 X 1.1/2.	\$0.160	500

PP08013	#8 X 1/2	\$0.180	1000
PP08019	#8 X 3/4.	\$0.260	1000
PP08025	#8 X 1".	\$0.470	500
PP08032	#8 X 1.1/4.	\$0.230	250
PP08038	#8 X 1.1/2	\$0.450	250
PP08051	#8 X 2"	\$0.290	250

PP10013	#10 X 1/2.	\$0.120	1000
PP10019	#10 X 3/4.	\$0.220	500
PP10025	#10 X 1".	\$0.200	400
PP10032	#10 X 1.1/4	\$0.280	250
PP10038	#10 X 1.1/2.	\$0.440	250
PP10051	#10 X 2".	\$0.580	200
PP10064	#10 X 2.1/2	\$1.230	100
PP10076	#10 X 3".	\$0.570	100

CLAVE	DESCRIPCIÓN	PRECIO POR PIEZA	E
PIJA PARA MADERA CON ARISTAS PUNTA 17 PHILLIPS NEGRA			
			
PMA06025	#6 x 1"	\$0.230	5,000
PMA06032	#6 x 1.1/4	\$0.160	4,500
PMA06038	#6 x 1.1/2	\$0.190	3,500
PMA06051	#6 x 2"	\$0.200	2,000

PMA08025	#8 x 1"	\$0.200	3,750
PMA08032	#8 x 1.1/4	\$0.310	3,000
PMA08038	#8 x 1.1/2	\$0.290	2,500
PMA08044	#8 x 1.3/4	\$0.410	2,250
PMA08051	#8 x 2"	\$0.360	1,500
PMA08064	#8 x 2-1/2	\$0.570	1,000
PMA08076	#8 x 3"	\$0.710	750

PMA10038	#10 x 1.1/2	\$0.270	1,900
PMA10051	#10 x 2"	\$0.480	1,500
PMA10064	#10 x 2-1/2	\$0.590	800
PMA10076	#10 x 3"	\$0.760	600

PMA12064	#12 x 2-1/2	\$0.990	500
PMA12076	#12 x 3"	\$1.220	400

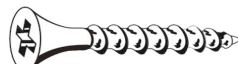
PIJA MULTIUSOS CUERDA ESTÁNDAR PHILLIPS NEGRA			
			
PMU06019	#6 x 3/4	\$0.170	6,000
PMU06025	#6 x 1"	\$0.180	5,000
PMU06032	#6 x 1.1/4	\$0.230	4,000
PMU06038	#6 x 1.1/2	\$0.250	3,000
PMU06041	#6 x 1.5/8	\$0.170	2,500
PMU06044	#6 x 1.3/4	\$0.290	2,000
PMU06051	#6 x 2"	\$0.350	1,800
PMU06057	#6 x 2-1/4	\$0.220	1,500

CLAVE	DESCRIPCIÓN	PRECIO POR PIEZA	E
PIJA MULTIUSOS CUERDA ESTÁNDAR PHILLIPS NEGRA			
			
PMU08025	#8 x 1"	\$0.200	3,750
PMU08032	#8 x 1-1/4	\$0.290	3,250
PMU08038	#8 x 1-1/2	\$0.370	2,750
PMU08051	#8 x 2"	\$0.300	1,500
PMU08064	#8 x 2-1/2	\$0.330	1,000
PMU08076	#8 x 3"	\$0.570	750

PMU10038	#10 x 1-1/2	\$0.380	2,100
PMU10051	#10 x 2"	\$0.440	1,350
PMU10064	#10 x 2-1/2	\$0.750	800
PMU10076	#10 x 3"	\$0.860	600
PMU10089	#10 x 3.1/2	\$1.290	500
PMU10102	#10 x 4"	\$0.660	400

PIJA PARA TABLAROCA CUERDA FINA PHILLIPS NEGRA			
			
PT06025	#6 X 1"	\$0.220	5,000
PT06032	#6 X 1.1/4	\$0.230	4,000
PT06038	#6 X 1.1/2	\$0.250	3,000
PT06041	#6 X 1.5/8	\$0.230	2,500
PT06051	#6 X 2"	\$0.360	2,000

PT08064	#8 X 2.1/2	\$0.470	1,000
PT08076	#8 X 3"	\$0.750	750

PT10089	#10 X 3.1/2	\$0.730	600
PT10102	#10 X 4"	\$0.890	400

CLAVE	DESCRIPCIÓN	PRECIO POR PIEZA	E
PIJA HEXAGONAL GALVANIZADA PUNTA BROCA 			
PEB08013	#8 x 1/2	\$0.150	4,250
PEB08019	#8 x 3/4	\$0.330	3,250
PEB08025	#8 x 1"	\$0.210	2,750
PEB08032	#8 x 1-1/4	\$0.450	2,400
PEB08038	#8 x 1-1/2	\$0.220	2,000

PEB10013	#10 x 1/2	\$0.300	3,000
PEB10019	#10 x 3/4	\$0.410	2,400
PEB10025	#10 x 1"	\$0.480	1,900
PEB10038	#10 x 1-1/2	\$0.330	1,500

PEB12019	#12 x 3/4	\$0.490	1,250
PEB12025	#12 x 1"	\$0.610	1,000

PEB14019	#14 x 3/4	\$0.480	1,250
PEB14025	#14 x 1"	\$0.920	1,000
PEB14032	#14 x 1-1/4	\$0.900	850
PEB14038	#14 x 1-1/2	\$1.210	750
PEB14051	#14 x 2"	\$1.390	600

PIJA HEXAGONAL GALVANIZADA PUNTA BROCA CON RONDANA EPDM 			
PEBR14019	#14 x 3/4	\$1.500	800
PEBR14025	#14 x 1"	\$1.430	800
PEBR14038	#14 x 1-1/2	\$1.420	700
PEBR14051	#14 x 2	\$1.120	500
PEBR14064	#14 x 2-1/2	\$2.490	400
PEBR14076	#14 x 3	\$1.500	300

CLAVE	DESCRIPCIÓN	PRECIO POR PIEZA	E
PIJA K-LATH PUNTA AGUDA GALVANIZADA PHILLIPS 			
PK08013	#8 x 1/2	\$0.210	4,750
PK08019	#8 x 3/4	\$0.120	3,800
PK08025	#8 x 1"	\$0.250	3,000
PK08032	#8 x 1-1/4	\$0.300	2,500
PK08038	#8 x 1-1/2	\$0.210	2,000

PK10013	#10 x 1/2	\$0.150	3,250
PK10019	#10 x 3/4	\$0.400	2,100

PIJA K-LATH PUNTA BROCA GALVANIZADA PHILLIPS 			
PKB08013	#8 x 1/2	\$0.290	4,000
PKB08019	#8 x 3/4	\$0.230	3,250
PKB08025	#8 x 1"	\$0.360	2,700
PKB08032	#8 x 1-1/4	\$0.420	2,400
PKB08038	#8 x 1-1/2	\$0.430	2,000
PKB08041	#8 x 1-5/8	\$0.320	1,850

CLAVE	DESCRIPCIÓN	PRECIO POR PIEZA	E
TORNILLOS PARA CONCRETO CABEZA HEXAGONAL			
FPCE632	1/4"x 1-1/4"	\$1.14	100
FPCE644	1/4"x 1-3/4"	\$0.80	100
FPCE657	1/4"x 2-1/4"	\$0.85	100
FPCE670	1/4"x 2-3/4"	\$1.43	100
FPCE683	1/4"x 3-1/4"	\$1.94	100
FPCE695	1/4"x 3-3/4"	\$3.72	100

CLAVE	DESCRIPCIÓN	PRECIO POR PIEZA	E
TORNILLOS PARA CONCRETO CABEZA PLANA PUNTA PHILLIPS			
FPCP632	1/4"x 1-1/4"	\$0.91	100
FPCP644	1/4"x 1-3/4"	\$1.70	100
FPCP657	1/4"x 2-1/4"	\$1.54	100
FPCP670	1/4"x 2-3/4"	\$1.09	100
FPCP683	1/4"x 3-1/4"	\$2.75	100
FPCP695	1/4"x 3-3/4"	\$2.65	100

SIN NECESIDAD DE TAQUETES
INSTALACIÓN

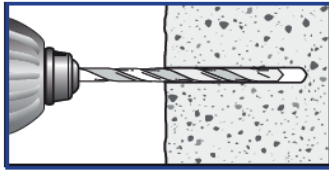

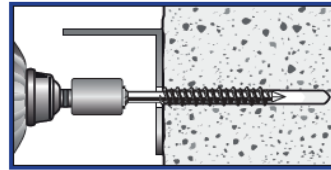

Perfore en el material base 1/2" más profundo que el empotramiento del anclaje, usando una broca de 3/16".

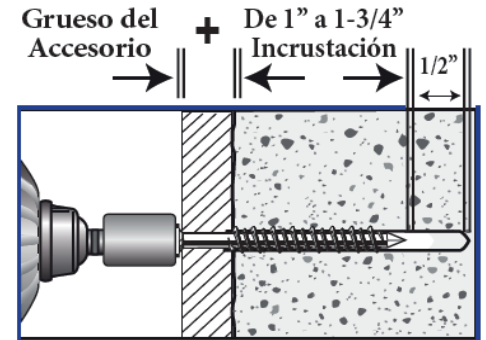

Inserte el Tornillo y Asegúrese de que penetre en el material base de 1" a 1-3/4". Use una punta Phillips #3 o una Llave de 5/16".

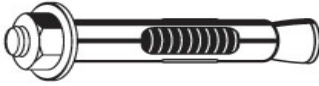

CLAVE	DESCRIPCIÓN	PRECIO POR PIEZA	E
ANCLA DE CAMISA ACERO INOXIDABLE			
FXTC06035	1/4"x1 3/8"	\$4.92	100
FXTC06048	3/8"x1 7/8"	\$11.25	50
FXTC09076	3/8"x3"	\$16.67	50
FXTC13057	1/2"x2 1/4"	\$19.96	25
FXTC13101	1/2"x4"	\$35.93	25
FXTC16107	5/8"x4 1/4"	\$30.54	10

CLAVE	DESCRIPCIÓN	PRECIO POR PIEZA	E
ANCLA ARPÓN ACERO INOXIDABLE			
FXTA06044	1/4"-20x1.3/4"	\$4.49	100
FXTA06057	1/4"-20x2.1/4"	\$8.39	100
FXTA06083	1/4"-20x3.1/4"	\$9.63	100

FXTA09057	3/8"-16x2.1/4"	\$9.26	50
FXTA09070	3/8"-16x2.3/4"	\$14.89	50
FXTA09076	3/8"-16x3"	\$14.51	50
FXTA09095	3/8"-16x3.3/4"	\$17.91	50
FXTA09127	3/8"-16x5"	\$22.62	50
FXTA09165	3/8"-16x6.1/2"	\$57.17	50

FXTA13070	1/2"-13x2.3/4"	\$14.98	25
FXTA13095	1/2"-13x3.3/4"	\$27.12	25
FXTA13108	1/2"-13x4.1/4"	\$35.32	25
FXTA13140	1/2"-13x5.1/2"	\$30.71	25
FXTA13178	1/2"-13x7"	\$47.73	25
FXTA13216	1/2"-13x8.1/2"	\$80.85	25
FXTA13254	1/2"-13x10"	\$50.12	25

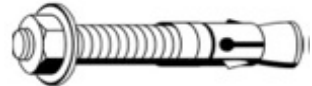
CLAVE	DESCRIPCIÓN	PRECIO POR PIEZA	E
ANCLA ARPÓN ACERO INOXIDABLE			
FXTA16089	5/8"-11x3.1/2"	\$61.77	25
FXTA16114	5/8"-11x4.1/2"	\$57.44	25
FXTA16127	5/8"-11x5"	\$43.65	20
FXTA16152	5/8"-11x6"	\$87.50	20
FXTA16178	5/8"-11x7"	\$51.94	25
FXTA16216	5/8"-11x8.1/2"	\$70.10	25
FXTA16254	5/8"-11x10"	\$82.51	10

FXTA19108	3/4"-10x4.1/4"	\$102.59	20
FXTA19121	3/4"-10x4.3/4"	\$111.45	20
FXTA19140	3/4"-10x5.1/2"	\$140.06	20
FXTA19158	3/4"-10x6.1/4"	\$128.76	10
FXTA19178	3/4"-10x7"	\$143.97	10
FXTA19216	3/4"-10x8.1/2"	\$99.04	10
FXTA19254	3/4"-10x10"	\$151.75	10

CLAVE	DESCRIPCIÓN	PRECIO POR PIEZA	E
TAQUETE PARA TABLAROCA TOGGLER			
			
F TTL06	Taquete Auto perforante	\$6.62	100

CLAVE	DESCRIPCIÓN	PRECIO POR PIEZA	E
ANCLA ROSCADA PARA PANELES			
			
F TR05	Ancla Roscada 3/16"-24	\$25.23	50
F TR06	Ancla Roscada 1/4"-20	\$25.23	50

CLAVE	DESCRIPCIÓN	PRECIO POR PIEZA	E
TAQUETE EXPANSOR ZINCADO			
			
F TZ05	3/16 - 24	\$3.98	100
F TZ06	1/4-20.	\$12.68	100
F TZ08	5/16-18.	\$14.90	50
F TZ09	3/8-16.	\$14.40	50
F TZ13	1/2-13.	\$22.99	25

CLAVE	DESCRIPCIÓN	PRECIO POR PIEZA	E
TAQUETE DE EXPANSIÓN			
			
F TE08	5/16-18.	\$4.44	100
F TE19	3/4-10.	\$21.30	100

CLAVE	DESCRIPCIÓN	PRECIO POR PIEZA	E
TAQUETE DE GOLPE			
			
F TG06	1/4-20 - 3/8 -1".	\$2.40	100
F TG09	3/8-16 - 1/2 -1.9/16	\$4.65	50
F TG13	1/2-13 - 5/8 - 2".	\$7.25	50
F TG16	5/8-11 - 7/8 - 2.1/2.	\$13.21	25
F TG19	3/4-10 - 1" - 3.1/8	\$32.54	25

CLAVE	DESCRIPCIÓN	PRECIO POR PIEZA	E
PUNZÓN PARA TAQUETE DE GOLPE			
			
F TGP06	1/4.	\$18.97	20
F TGP08	3/8.	\$22.61	10
F TGP13	1/2.	\$43.92	10
F TGP16	5/8.	\$27.92	5
F TGP19	3/4.	\$35.70	5

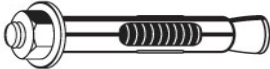
CLAVE	DESCRIPCIÓN	PRECIO POR PIEZA	E
ANCLA DE CAMISA			
			
F TC06057	1/4-20 X 2.1/4	\$2.31	100
F TC08064	5/16-18 X 2.1/2	\$3.50	50
F TC09076	3/8-16 X 3".	\$6.54	50
F TC13076	1/2-13 X 3".	\$9.89	25
F TC13152	1/2"x6"	\$8.91	25
F TC16108	5/8"x4 1/4"	\$22.05	20
F TC19108	3/4"x4 1/4"	\$34.98	10

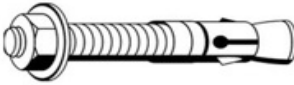
CLAVE	DESCRIPCIÓN	PRECIO POR PIEZA	E
ANCLA ARPÓN			
FTA06044	1/4-20 X 1.3/4	\$2.40	100
FTA06057	1/4-20 X 2.1/4	\$2.67	100
FTA06076	1/4-20 X 3".	\$2.96	100

FTA08051	5/16-18 X 2".	\$3.50	50
FTA08070	5/16-18 X 2.3/4	\$3.94	50
FTA08089	5/16-18 X 3.1/2	\$4.41	50

FTA09057	3/8-16 X 2.1/4	\$4.84	50
FTA09070	3/8-16 X 2.3/4	\$5.40	50
FTA09076	3/8-16 X 3".	\$5.66	50
FTA09089	3/8-16 X 3.1/2	\$6.17	50
FTA09095	3/8-16 X 3.3/4	\$7.29	50
FTA09127	3/8-16 X 5".	\$7.70	50
FTA09165	3/8"-16x6 1/2"	\$9.51	50

FTA13070	1/2-13 X 2.3/4	\$9.63	25
FTA13095	1/2-13 X 3.3/4	\$11.30	25
FTA13114	1/2-13 X 4.1/2	\$14.64	25
FTA13140	1/2-13 X 5.1/2	\$14.59	25
FTA13178	1/2-13 X 7".	\$17.87	25
FTA13216	1/2"-13x8 1/2"	\$24.28	25
FTA13254	1/2"-13x10"	\$24.77	25

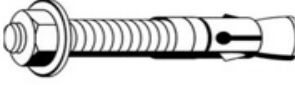
CLAVE	DESCRIPCIÓN	PRECIO POR PIEZA	E
ANCLA ARPÓN			
FTA16089	5/8-11 X 3.1/2	\$17.55	25
FTA16114	5/8-11 X 4.1/2	\$20.47	20
FTA16127	5/8-11 X 5".	\$21.86	20
FTA16152	5/8-11 X 6".	\$24.12	20
FTA16178	5/8-11 X 7".	\$31.61	20
FTA16216	5/8"-11x8 1/2"	\$33.01	20
FTA16254	5/8"-11x10"	\$40.10	20

FTA19108	3/4-10 X 4.1/4	\$30.55	10
FTA19121	3/4-10 X 4.3/4	\$37.28	10
FTA19140	3/4-10 X 5.1/2	\$35.71	10
FTA19158	3/4-10 X 6.1/4	\$37.37	10
FTA19178	3/4-10 X 7".	\$42.85	10
FTA19216	3/4-10 X 8.1/2.	\$24.41	10
FTA19254	3/4"-10x10"	\$60.50	10
FTA19305	3/4"-10x12"	\$74.01	10

FTA22152	7/8"-9x6"	\$57.21	5
FTA22203	7/8"-9x8"	\$73.45	5
FTA22254	7/8"-9x10"	\$91.28	5

FTA25152	1"-8x6"	\$74.72	5
FTA25229	1"-8x9"	\$104.99	5
FTA25305	1"-8x12"	\$118.23	5

CLAVE	DESCRIPCIÓN	PRECIO POR PIEZA	E
TAQUETES COLOR NEGRO			
FDP005	3/16"	\$0.496	100
FDP006	1/4"	\$0.617	100
FDP006L	1/4" L	\$0.914	100
FDP008	5/16"	\$0.748	100
FDP009	3/8"	\$1.077	100
FDP013	1/2"	\$1.784	25

TAQUETE PARA TABLAROCA NYLON BLANCO			
FDT012	1/2	\$1.151	100

GRAPAS DE NYLON			
FDGC460	Cuadrada 460 Naranja	\$0.738	100
FDGC580	Cuadrada 580 Roja	\$0.924	100
FDGC610	Cuadrada 610 Amarilla	\$1.128	100
FDGR710	Redonda 710 Verde	\$0.989	100

ABRAZADERAS DE NYLON			
FDAG13	Gris 1/2	\$2.863	25
FDAG19	Gris 3/4	\$3.286	25
FDAG25	Gris 1"	\$3.789	25
FDAV13	Verde 1/2	\$2.863	25
FDAV19	Verde 3/4	\$3.286	25

CLAVE	DESCRIPCIÓN	PRECIO POR PIEZA	E
CINCHOS DE NYLON COLOR NATURAL (BLANCO)			
FDB3100	2.5 x 100 mm	\$0.203	100
FDB3150	2.5 x 150 mm	\$0.325	100
FDB3200	2.5 x 200 mm	\$0.433	100
FDB4150	3.6 x 150 mm	\$0.502	100
FDB4200	3.6 x 200 mm	\$0.653	100
FDB4370	3.6 x 370 mm	\$1.573	100
FDB5200	4.8 x 200 mm	\$0.952	100
FDB5280	4.8 x 280 mm	\$1.381	100
FDB5370	4.8 x 370 mm	\$1.957	100
FDB5430	4.8 x 430 mm	\$2.421	100

CINCHOS DE NYLON COLOR NEGRO			
FDN3100	2.5 x 100 mm	\$0.203	100
FDN3150	2.5 x 150 mm	\$0.325	100
FDN3200	2.5 x 200 mm	\$0.433	100
FDN4150	3.6 x 150 mm	\$0.502	100
FDN4200	3.6 x 200 mm	\$0.653	100
FDN4370	3.6 x 370 mm	\$1.573	100
FDN5200	4.8 x 200 mm	\$0.952	100
FDN5280	4.8 x 280 mm	\$1.381	100
FDN5370	4.8 x 370 mm	\$1.957	100
FDN5430	4.8 x 430 mm	\$2.421	100

CLAVE	DESCRIPCIÓN	PRECIO POR PIEZA	E
CHAVETAS 			
FC01013	1/16 X 1/2.	\$0.440	800
FC01019	1/16 X 3/4	\$0.510	400
FC01025	1/16 X 1".	\$0.630	300
FC01032	1/16 X 1.1/4.	\$0.730	200
FC01038	1/16 X 1.1/2.	\$0.870	100
FC01051	1/16 X 2"	\$1.420	100

FC02013	3/32 X 1/2.	\$0.450	300
FC02019	3/32 X 3/4	\$0.500	200
FC02025	3/32 X 1".	\$0.630	100
FC02032	3/32 X 1.1/4.	\$0.710	100
FC02038	3/32 X 1.1/2.	\$0.840	100
FC02051	3/32 X 2".	\$1.010	50

FC03013	1/8 X 1/2	\$0.630	250
FC03019	1/8 X 3/4	\$0.780	150
FC03025	1/8 X 1".	\$0.890	100
FC03032	1/8 X 1.1/4	\$1.050	100
FC03038	1/8 X 1.1/2	\$1.170	100
FC03051	1/8 X 2"	\$1.520	100
FC03064	1/8 X 2.1/2	\$1.820	50
FC03076	1/8 X 3".	\$2.130	50

FC04013	5/32 X 1/2.	\$0.840	150
FC04019	5/32 X 3/4.	\$1.010	100
FC04025	5/32 X 1".	\$1.250	100
FC04032	5/32 X 1.1/4	\$1.450	100
FC04038	5/32 X 1.1/2	\$1.750	100
FC04051	5/32 X 2".	\$2.090	50
FC04064	5/32 X 2.1/2.	\$2.470	50
FC04076	5/32 X 3".	\$2.880	30

CLAVE	DESCRIPCIÓN	PRECIO POR PIEZA	E
CHAVETAS 			
FC05013	3/16 X 1/2.	\$1.120	200
FC05019	3/16 X 3/4.	\$1.560	150
FC05025	3/16 X 1"	\$1.850	150
FC05032	3/16 X 1.1/4.	\$2.220	100
FC05038	3/16 X 1.1/2	\$2.540	100
FC05051	3/16 X 2"	\$3.070	80
FC05064	3/16 X 2.1/2	\$3.740	50
FC05076	3/16 X 3".	\$4.260	50
FC05089	3/16 X 3.1/2	\$4.910	50
FC05102	3/16 X 4".	\$5.320	50

FC06025	1/4 X 1"	\$2.960	150
FC06032	1/4 X 1.1/4	\$3.230	150
FC06038	1/4 X 1.1/2.	\$3.980	100
FC06051	1/4 X 2"	\$4.710	100
FC06064	1/4 X 2.1/2.	\$5.630	50
FC06076	1/4 X 3"	\$6.580	50
FC06089	1/4 X 3.1/2.	\$7.680	50
FC06102	1/4 X 4"	\$9.030	50

FC08025	5/16 X 1"	\$4.430	100
FC08032	5/16 X 1.1/4	\$4.890	100
FC08038	5/16 X 1.1/2.	\$5.850	100
FC08051	5/16 X 2"	\$6.830	50
FC08064	5/16 X 2.1/2.	\$8.500	50
FC08076	5/16 X 3"	\$9.740	50
FC08089	5/16 X 3.1/2.	\$11.210	50
FC08102	5/16 X 4"	\$12.560	50

FC09038	3/8 X 1.1/2.	\$9.550	50
FC09051	3/8 X 2"	\$11.570	50
FC09064	3/8 X 2.1/2.	\$13.340	50
FC09076	3/8 X 3"	\$15.920	25
FC09089	3/8 X 3.1/2.	\$18.750	25
FC09102	3/8 X 4"	\$21.620	25

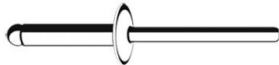
CLAVE	DESCRIPCIÓN	PRECIO POR PIEZA	E
REMACHES TOLEDO ACERO INOXIDABLE			
			
FXR41	1/8 X 3/16 X (1/16)	\$0.77	100
FXR42	1/8 X 1/4 X (1/8).	\$0.85	100
FXR43	1/8 X 5/16 X (3/16).	\$0.80	100
FXR44	1/8 X 3/8 X (1/4).	\$0.87	100
FXR45	1/8 X 7/16 X (5/16).	\$0.86	100
FXR46	1/8 X 1/2 X (3/8).	\$0.93	100
FXR48	1/8 X 5/8 X (1/2).	\$1.05	100

FXR52	5/32 X 1/4 X (1/8).	\$1.11	100
FXR54	5/32 X 3/8 X (1/4).	\$1.22	100
FXR56	5/32 X 1/2 X (3/8).	\$1.36	100
FXR58	5/32 X 5/8 X (1/2).	\$1.51	100
FXR510	5/32 X 3/4 X (5/8).	\$0.92	100

FXR62	3/16 X 1/4 X (1/8).	\$1.46	100
FXR64	3/16 X 3/8 X (1/4).	\$1.78	100
FXR66	3/16 X 1/2 X (3/8).	\$1.94	100
FXR68	3/16 X 5/8 X (1/2).	\$2.18	100
FXR610	3/16 X 3/4 X (5/8).	\$2.17	50
FXR612	3/16 X 7/8 X (3/4).	\$1.98	50

FXR84	1/4 X 3/8 X (1/4).	\$3.40	50
FXR86	1/4 X 1/2 X (3/8).	\$4.02	50
FXR88	1/4 X 5/8 X (1/2).	\$3.95	50

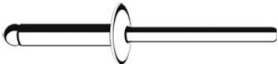
REMACHES DE CLAVO ALUMINIO /ACERO TOLEDO ALA ESTÁNDAR			
			
FR41	1/8 X 3/16 X (1/16)	\$0.240	1,000
FR42	1/8 X 1/4 X (1/8).	\$0.230	1,000
FR43	1/8 X 5/16 X (3/16).	\$0.220	1,000
FR44	1/8 X 3/8 X (1/4).	\$0.250	1,000
FR45	1/8 X 7/16 X (5/16).	\$0.230	1,000
FR46	1/8 X 1/2 X (3/8).	\$0.250	1,000
FR48	1/8 X 5/8 X (1/2).	\$0.280	1,000
FR410	1/8 X 3/4 X (5/8).	\$0.300	1,000

CLAVE	DESCRIPCIÓN	PRECIO POR PIEZA	E
REMACHES DE CLAVO ALUMINIO/ ACERO TOLEDO ALA ESTÁNDAR			
			
FR52	5/32 X 1/4 X (1/8).	0.290	1,000
FR54	5/32 X 3/8 X (1/4).	0.370	1,000
FR56	5/32 X 1/2 X (3/8).	0.350	1,000
FR58	5/32 X 5/8 X (1/2).	0.400	500
FR510	5/32 X 3/4 X (5/8).	0.440	500
FR512	5/32 X 7/8 X (3/4).	0.480	500

FR62	3/16 X 1/4 X (1/8).	0.430	500
FR64	3/16 X 3/8 X (1/4).	0.460	500
FR66	3/16 X 1/2 X (3/8).	0.520	500
FR68	3/16 X 5/8 X (1/2).	0.580	500
FR610	3/16 X 3/4 X (5/8).	0.630	250
FR612	3/16 X 7/8 X (3/4).	0.760	250
FR614	3/16 X 1 X (7/8).	0.780	250
FR616	3/16 X 1.1/8 X (1").	0.560	250

FR84	1/4 X 3/8 X (1/4).	1.010	350
FR86	1/4 X 1/2 X (3/8).	1.080	350
FR88	1/4 X 5/8 X (1/2).	1.260	300

REMACHE TOLEDO ALA ANCHA			
FRL64	3/16 X 3/8 X (1/4).	0.780	250
FRL66	3/16 X 1/2 X (3/8).	0.850	250
FRL68	3/16 X 5/8 X (1/2).	0.910	250
FRL610	3/16 X 3/4 X (5/8).	0.980	250
FRL612	3/16 X 7/8 X (3/4).	1.010	250

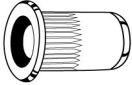
TUERCAS REMACHABLES TOLEDO ZINCADA			
			
FNR05	#10-24X0.475"	\$2.29	100
FNR05L	#10-24X0.585"L	\$2.48	100
FNR06	1/4-20X0.58"	\$3.22	100
FNR06L	1/4-20X0.68"L	\$2.83	100
FNR08	5/16-18X0.69"	\$4.29	100
FNR08L	5/16-18X0.805"L	\$5.12	100
FNR09	3/8-16X0.69"	\$4.08	100
FNR09L	3/8-16X0.805"L	\$6.35	100

CLAVE	DESCRIPCIÓN	PRECIO POR PIEZA	E
REMACHE DE CLAVO ALUMINIO/ ACERO EN CAJA INDUX ALA ESTÁNDAR			
			
FN32	AS-32 (3/32" x 2/16")	\$0.470	2,000
FN34	AS-34 (3/32" x 4/16")	\$0.476	2,000
FN41	AS-41 (1/8" x 1/16")	\$0.479	1,000
FN42	AS-42 (1/8" x 2/16")	\$0.500	1,000
FN43	AS-43 (1/8" x 3/16")	\$0.514	1,000
FN44	AS-44 (1/8" x 4/16")	\$0.528	1,000
FN45	AS-45 (1/8" x 5/16")	\$0.542	1,000
FN46	AS-46 (1/8" x 6/16")	\$0.549	1,000
FN48	AS-48 (1/8" x 8/16")	\$0.594	1,000
FN52	AS-52 (5/32" x 2/16")	\$0.727	1,000
FN54	AS-54 (5/32" x 4/16")	\$0.768	1,000
FN56	AS-56 (5/32" x 6/16")	\$0.810	1,000
FN58	AS-58 (5/32" x 8/16")	\$0.887	500
FN59	AS-510 (5/32" x 10/16")	\$0.948	500
FN62	AS-62 (3/16" x 2/16")	\$0.987	500
FN64	AS-64 (3/16" x 4/16")	\$1.089	500
FN66	AS-66 (3/16" x 6/16")	\$1.163	500
FN68	AS-68 (3/16" x 8/16")	\$1.348	500
FN610	AS-610 (3/16" x 10/16")	\$1.396	500
FN612	AS-612 (3/16" x 12/16")	\$1.571	500
FN614	AS-614 (3/16" x 14/16")	\$1.766	200
FN616	AS-616 (3/16" x 16/16")	\$1.841	200
FN84	AS-84 (1/4" x 4/16")	\$1.761	200
FN86	AS-86 (1/4" x 6/16")	\$1.825	200
FN88	AS-88 (1/4" x 8/16")	\$2.113	200

CLAVE	DESCRIPCIÓN	PRECIO POR PIEZA	E
REMACHE DE CLAVO ALUMINIO/ ACERO EN BOLSA INDUX ALA ESTÁNDAR			
			
FNB32	AS-32 (3/32" x 2/16")	\$0.495	100
FNB34	AS-34 (3/32" x 4/16")	\$0.500	100
*FNB41	AS-41 (1/8" x 1/16")	\$0.490	100
FNB42	AS-42 (1/8" x 2/16")	\$0.521	100
FNB43	AS-43 (1/8" x 3/16")	\$0.540	100
FNB44	AS-44 (1/8" x 4/16")	\$0.554	100
FNB45	AS-45 (1/8" x 5/16")	\$0.568	100
FNB46	AS-46 (1/8" x 6/16")	\$0.575	100
FNB48	AS-48 (1/8" x 8/16")	\$0.626	100
FNB52	AS-52 (5/32" x 2/16")	\$0.762	100
FNB54	AS-54 (5/32" x 4/16")	\$0.804	100
FNB56	AS-56 (5/32" x 6/16")	\$0.847	100
FNB58	AS-58 (5/32" x 8/16")	\$0.909	100
FNB510	AS-510 (5/32" x 10/16")	\$0.995	100
FNB62	AS-62 (3/16" x 2/16")	\$1.036	100
FNB64	AS-64 (3/16" x 4/16")	\$1.131	100
FNB66	AS-66 (3/16" x 6/16")	\$1.207	100
FNB68	AS-68 (3/16" x 8/16")	\$1.395	100
FNB610	AS-610 (3/16" x 10/16")	\$1.490	100
FNB612	AS-612 (3/16" x 12/16")	\$1.599	100
FNB614	AS-614 (3/16" x 14/16")	\$1.794	100
FNB616	AS-616 (3/16" x 16/16")	\$1.920	100
FNB84	AS-84 (1/4" x 4/16")	\$1.789	100
FNB86	AS-86 (1/4" x 6/16")	\$1.887	100
FNB88	AS-88 (1/4" x 8/16")	\$2.141	100

REMACHE INDUX ALA ANCHA EN CAJA			
FNA66	AS-66 (3/16" x 6/16") CA	\$1.735	500
FNA68	AS-68 (3/16" x 8/16") CA	\$1.857	200
FNA610	AS-610 (3/16" x 10/16") CA	\$2.015	200
FNA612	AS-612 (3/16" x 12/16") CA	\$2.225	200
FNA614	AS-614 (3/16" x 14/16") CA	\$2.501	200
FNA616	AS-616 (3/16" x 16/16") CA	\$2.700	200

REMACHE INDUX ALA ANCHA EN BOLSA			
FNAB66	AS-66 (3/16" x 6/16") CA	\$1.824	100
FNAB68	AS-68 (3/16" x 8/16") CA	\$1.940	100
FNAB610	AS-610 (3/16" x 10/16")CA	\$2.122	100
FNAB612	AS-612 (3/16" x 12/16") CA	\$2.295	100

CLAVE	DESCRIPCIÓN	PRECIO POR PIEZA	E
REMACHES DE CLAVO ALUMINIO/ ACERO DE COLOR INDUS ALA ESTÁNDAR			
			
FNB430AN	AS-43 (1/8" x 3/16") NEGRO	\$0.600	100
FNB430AU	AS-43 (1/8" x 3/16") ORO	\$0.596	100
FNB430BL	AS-43 (1/8" x 3/16") BLANCO	\$0.580	100
FNB430BR	AS-43 (1/8" x 3/16") BRONCE	\$0.595	100
FNB440AN	AS-44 (1/8" x 4/16") NEGRO	\$0.576	100
FNB440AU	AS-44 (1/8" x 4/16") ORO	\$0.596	100
FNB440BL	AS-44 (1/8" x 4/16") BLANCO	\$0.580	100
FNB440BR	AS-44 (1/8" x 4/16") BRONCE	\$0.595	100
FNB450AN	AS-45 (1/8" x 5/16") NEGRO	\$0.636	100
FNB450AU	AS-45 (1/8" x 5/16") ORO	\$0.630	100
FNB450BL	AS-45 (1/8" x 5/16") BLANCO	\$0.628	100
FNB450BR	AS-45 (1/8" x 5/16") BRONCE	\$0.631	100
FNB450CH	AS-45 (1/8" x 5/16") CHAMPAGNE	\$0.738	100
FNB460AN	AS-46 (1/8" x 6/16") NEGRO	\$0.645	100
FNB460AU	AS-46 (1/8" x 6/16") ORO	\$0.639	100
FNB460BL	AS-46 (1/8" x 6/16") BLANCO	\$0.637	100
FNB460CH	AS-46 (1/8" x 6/16") CHAMPAGNE	\$0.754	100
FNB480AN	AS-48 (1/8" x 8/16") NEGRO	\$0.699	100
FNB480AU	AS-48 (1/8" x 8/16") ORO	\$0.692	100
FNB480BL	AS-48 (1/8" x 8/16") BLANCO	\$0.692	100
FNB480BR	AS-48 (1/8" x 8/16") BRONCE	\$0.692	100
FNB480CH	AS-46 (1/8" x 8/16") CHAMPAGNE	\$0.815	100
FNB540AN	AS-54 (5/32" x 4/16") NEGRO	\$0.892	100
FNB540AU	AS-54 (5/32" x 4/16") ORO	\$0.884	100
FNB540BL	AS-54 (5/32" x 4/16") BLANCO	\$0.881	100
FNB540BR	AS-54 (5/32" x 4/16") BRONCE	\$0.884	100
FNB540CH	AS-54 (5/32" x 4/16") CHAMPAGNE	\$0.881	100
FNB560AN	AS-56 (5/32" x 6/16") NEGRO	\$0.947	100
FNB560AU	AS-56 (5/32" x 6/16") ORO	\$0.938	100
FNB560BL	AS-56 (5/32" x 6/16") BLANCO	\$0.937	100
FNB560BR	AS-56 (5/32" x 6/16") BRONCE	\$0.938	100
FNB560CH	AS-56 (5/32" x 6/16") CHAMPAGNE	\$1.116	100
FNB680AN	AS-68 (3/16" x 8/16") NEGRO	\$1.570	100

CLAVE	DESCRIPCIÓN	PRECIO POR PIEZA	E
REMACHE DE CLAVO MULTIAGARRE INDUS			
			
FNMA640	6-40 6/32"X4/16"	\$1.333	500
FNMA660	6-60 6/32X6/16	\$1.511	500
FNMA680	6-80 6/32"X8/16"	\$1.636	500

CLAVE	DESCRIPCIÓN	PRECIO POR PIEZA	E
REMACHE DE CLAVO SELLADO INDUS			
			
FNSD640	AS-64 3/16" x 4/16"	\$2.230	500
FNSD660	AS-66 3/16" x 6/16"	\$2.490	500
FNSD680	AS-68 3/16" x 8/16"	\$2.520	500

CLAVE	DESCRIPCIÓN	PRECIO POR PIEZA	E
REMACHES DE CLAVO ACERO - ACERO INDUS			
			
FNZ420	SS-42 1/8" X 2/16"	\$0.660	1,000
*FNZ44	SS-44 1/8" X 2/16"	\$0.590	1,000
FNZ66	SS-66 3/16" x 6/16"	\$1.685	500
FNZ66CA	SS-66 3/16" x 6/16" CA	\$2.004	200
FNZ680	SS-68 3/16" x 8/16"	\$1.953	500
FNZ840	SS-84 1/4" x 4/16" ZI	\$2.823	200

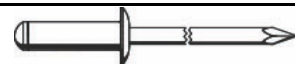
CLAVE	DESCRIPCIÓN	PRECIO POR PIEZA	E
REMACHE TRÉBOL ALUMINIO			
			
FNTA52	52 (5/32" x 2/16")	\$4.37	100
FNTA54	54 (5/32" x 4/16")	\$4.41	100
FNTA56	56 (5/32" x 6/16")	\$4.53	100
FNTA62	62 (3/16" x 2/16")	\$4.83	100
FNTA64	64 (3/16" x 4/16")	\$5.47	100
FNTA66	66 (3/16" x 6/16")	\$5.70	100
FNTA68	68 (3/16" x 8/16")	\$6.77	100

*Por discontinuar

CLAVE	DESCRIPCIÓN	PRECIO POR PIEZA	E
REMACHE ESTRUCTURAL SERIE LOCK			
FNEL66	66 (3/16" x 6/16")	\$10.81	100
FNEL68	68 (3/16" x 8/16")	\$13.46	100
FNEL610	610 (3/16" x 10/16")	\$11.58	100
FNEL6	86 (1/4" x 6/16")	\$13.05	100

CLAVE	DESCRIPCIÓN	PRECIO POR PIEZA	E
REMACHE ESTRUCTURAL SERIE BULBO			
FNEB64	64 (3/16" x 4/16")	\$11.58	100
FNEB66	66 (3/16" x 6/16")	\$12.07	100
FNEB86	86 (1/4" x 6/16")	\$13.38	100
FNEB810	810 (1/4" x 10/16")	\$14.85	100

CLAVE	DESCRIPCIÓN	PRECIO POR PIEZA	E
REMACHE PARA BALATA			
FNTB0303	3-3 (.145 * 3/16")	\$0.178	1000
FNTB0404	4-4 (.145 x 4/16")	\$0.218	1000
FNTB0703	7-3 (3/16"x 3/16")	\$0.276	1000
FNTB0704	7-4 (3/16" x 4/16")	\$0.296	1000
FNTB0707	7-7 (3/16" x 7/16")	\$0.420	1000
FNTB0708	7-8 (3/16" x 8/16")	\$0.489	1000
FNTB0818	8-18 (.315 x 47/16")	\$2.079	500
FNTB1009	10-9 (1/4" x 9/16")	\$0.964	500
FNTB1010	10-10 (1/4" x 10/16")	\$1.017	500
FNTB1010A	10-10 (1/4" x 12/16") AL	\$1.357	500

CLAVE	DESCRIPCIÓN	PRECIO POR PIEZA	E
REMACHES PARA CLUTCH			
FNTC43	43 DIAF MERC. BENZ 40" (.315 x 1")	\$8.26	500
FNTC47	47 TACON CHICO X 4 (3/8" x 11/32")	\$2.31	500

CLAVE	DESCRIPCIÓN	PRECIO POR PIEZA	E
REMACHE DE GOLPE CARROCERO INDUS			
FNQ2215	SUAVE 5/32 X 1/4	\$363.00	1 Kg.
FNQ2220	SUAVE 5/32 X 3/8	\$363.00	1 Kg.
FNQ2223	SUAVE 5/32 X 5/8	\$363.00	1 Kg.
FNQ2226	SUAVE 5/32 X 3/4	\$363.00	1 Kg.
FNQ2228	SUAVE 5/32 X 1"	\$363.00	1 Kg.
FNQ2235	SUAVE 3/16 X 1/4	\$364.00	1 Kg.
FNQ2252	SUAVE 3/16 X 3/8	\$364.00	1 Kg.
FNQ2274	SUAVE 3/16 X 1/2	\$364.00	1 Kg.
FNQ2288	SUAVE 3/16 X 5/8	\$364.00	1 Kg.
FNQ2296	SUAVE 3/16 X 3/4	\$364.00	1 Kg.
FNQ2305	SUAVE 3/16 X 1"	\$364.00	1 Kg.
FNQ2320	SUAVE 1/4 X 3/8	\$364.00	1 Kg.
FNQ2330	SUAVE 1/4 X 1/2	\$364.00	1 Kg.
FNQ2342	SUAVE 1/4 X 5/8	\$364.00	1 Kg.
FNQ2353	SUAVE 1/4 X 3/4	\$364.00	1 Kg.
FNQ2359	SUAVE 1/4 X 7/8	\$364.00	1 Kg.
FNQ2364	SUAVE 1/4 X 1"	\$364.00	1 Kg.
FNY2254	DURO 3/16 X 3/8	\$805.00	1 Kg.
FNY2276	DURO 3/16 X 1/2	\$805.00	1 Kg.
FNY2289	DURO 3/16 X 5/8	\$805.00	1 Kg.
FNY2331	DURO 1/4 X 1/2	\$799.00	1 Kg.
FNY2343	DURO 1/4 X 5/8	\$805.00	1 Kg.
FNY2354	DURO 1/4 X 3/4	\$805.00	1 Kg.
FNY6936	DURO 1/4 X 7/8	\$805.00	1 Kg.
FNY2389	DURO 3/8 X 3/4	\$1,321.00	1 Kg.

CLAVE	DESCRIPCIÓN	PRECIO POR PIEZA	E
REMACHE DE EXPANSIÓN			
FNE03103	3-1-03	\$2.52	1,000
FNE03105	3-1-05	\$2.90	1,000
FNE03107	3-1-07	\$3.19	1,000
FNE03109	3-1-09	\$3.34	1,000
FNE03111	3-1-11	\$3.43	1,000
FNE03113	3-1-13	\$3.43	1,000
FNE03115	3-1-15	\$3.43	1,000
FNE03117	3-1-17	\$3.34	1,000
FNE03204	3-2-04	\$3.47	1,000
FNE03206	3-2-06	\$3.71	1,000
FNE03208	3-2-08	\$3.99	1,000
FNE04103	4-1-03	\$4.03	1,000
FNE04105	4-1-05	\$4.40	500
FNE04107	4-1-07	\$4.84	500
FNE04109	4-1-09	\$5.10	500
FNE04111	4-1-11	\$5.51	500
FNE04113	4-1-13	\$5.99	500
FNE04115	4-1-15	\$6.42	500
FNE04117	4-1-17	\$6.91	500

CLAVE	DESCRIPCIÓN	PRECIO POR PIEZA	E
POSTES DE ALUMINIO			
FNP06	6mm 1/4"	\$3.68	100
FNP09	9mm 3/8"	\$4.10	100
FNP12	12mm 1/2"	\$4.16	100
FNP15	15mm 5/8"	\$4.52	100
FNP19	19mm 3/4"	\$5.37	100
FNP25	25mm 1"	\$5.52	100
FNP31	31mm 1 1/4"	\$6.10	100
FNP38	38mm 1 1/2"	\$6.73	100
FNP44	44mm 1 3/4"	\$7.15	100
FNP50	50mm 2"	\$7.73	100
FNP75	75mm 3"	\$12.62	100
FNP89	89mm 3 1/2"	\$14.73	100
FNP100	100mm 4"	\$15.46	100

CLAVE	DESCRIPCIÓN	PRECIO POR PIEZA	E
GRASERAS 			
FNH100	1/4" -28 RECTA	\$5.49	100
FNH100LA	1/4" -28 LGA	\$10.37	100
FNH145	1/4" -28.45°	\$12.91	100
FNH190A	1/4" -28.90°	\$12.91	100
FNH200	1/8" PTF RECTA	\$8.65	100
FNH200LA	1/8" PTF LGA	\$21.26	100
FNH200LM	1/8" PTF LGA MEDIA	\$15.80	100
FNH245	1/8" PTF 45°	\$13.37	100
FNH290	1/8" PTF 90°	\$14.62	100
FNH300	1/4" PTF RECTA	\$18.01	100
*FNH51624	5/16" -24° UNEF-2A RECTA	\$4.06	100
*FNH290LMA	1/8" PTF 90° LGA M.	\$13.87	50
FNH51632	5/16 RECTA	\$7.61	100
FNH200B	1/8-27 C. BOTON	\$22.50	100
FNH300B	1/4-18 C. BOTON	\$24.66	100
FNH345	1/4-18 A 45° NPT	\$25.13	100
FNH390	1/4-18 A 90° NPT	\$25.30	100
FNH400	RECTA 3/8-18 NPT	\$49.62	100
FNH200R	REC 1/8-27 NPT	\$24.44	100
FNH316P	3/16 PRESION	\$8.12	100
FNH100GM	1/4" -28 AUTORSCANTE	\$5.44	100
FNH100V	8x1 mm AUTOROSC. 3/8"	\$7.52	100

CLAVE	DESCRIPCIÓN	PRECIO POR PIEZA	E
GRASERAS MÉTRICAS 			
FNGM06R	M6X1 RECTA	\$6.03	100
FNGM0645	M6X1 a 45°	\$14.18	100
FNGM0690	M6X1 a 90°	\$13.02	100
FNGM08R	M8X1 RECTA	\$8.22	100
FNGM0845	M8X1 a 45°	\$13.02	100
FNGM0890	M8X1 a 90°	\$13.02	100
FNGM10R	M10X1 RECTA	\$8.73	100
FNGM1045	M10X1 a 45°	\$14.64	100
FNGM1090	M10X1 a 90°	\$16.84	100

*Por descontinuar

CLAVE	DESCRIPCIÓN	PRECIO POR PIEZA	E
ANILLOS DE RETENCIÓN INTERNOS			
			
FNR13025	1/4	\$2.81	100
FNR13031	5/16	\$2.75	100
FNR13037	3/8	\$2.87	100
FNR13043	7/16	\$2.94	100
FNR13045	29/64	\$3.00	100
FNR13050	1/2	\$3.12	100
FNR13056	9/16	\$3.31	100
FNR13062	5/8	\$3.48	100
FNR13068	11/16	\$3.71	100
FNR13075	3/4	\$3.90	100
FNR13077	0.777	\$3.96	100
FNR13081	13/16	\$3.98	100
FNR13086	0.866	\$4.14	100
FNR13087	7/8	\$4.09	100
FNR13090	0.901	\$4.31	100
FNR13093	15/16	\$4.51	100
FNR13100	1"	\$4.76	100
FNR13102	1.023	\$5.17	100
FNR13106	1.1/16	\$6.05	100
FNR13112	1.1/8	\$6.28	100
FNR13118	1.3/16	\$6.42	100
FNR13125	1.1/4	\$7.21	50
FNR13131	1.5/16	\$7.20	50
FNR13137	1.3/8	\$7.96	50
FNR13143	1.7/16	\$8.27	50
FNR13145	1.456	\$8.76	50
FNR13150	1.1/2	\$9.16	50
FNR13156	1.9/16	\$11.13	50
FNR13162	1.5/8	\$11.27	50
FNR13165	1.653	\$17.25	50
FNR13168	1.11/16	\$17.82	25
FNR13175	1.3/4	\$17.92	25
FNR13181	1.13/16	\$18.12	25
FNR13187	1.7/8	\$18.03	25

CLAVE	DESCRIPCIÓN	PRECIO POR PIEZA	E
ANILLOS DE RETENCIÓN INTERNOS			
			
FNR13193	1.15/16	\$19.21	25
FNR13200	2"	\$19.23	25
FNR13206	2.1/16	\$23.30	25
FNR13212	2.1/8	\$24.39	25
FNR13218	2.3/16	\$24.62	25
FNR13225	2.1/4	\$25.85	25
FNR13231	2.5/16	\$26.53	25
FNR13237	2.3/8	\$28.59	25
FNR13244	2.7/16	\$29.85	20
FNR13250	2.1/2	\$31.79	20
FNR13275	2.3/4	\$54.40	5
FNR13300	3"	\$67.50	5
FNR13312	3.1/8	\$97.50	5
FNR13325	3.1/4	\$97.80	5
FNR13350	3.1/2	\$114.10	5
FNR13375	3.3/4	\$140.20	5
FNR13400	4"	\$185.90	1
FNR13425	4.1/4	\$196.60	1
FNR13450	4.1/2	\$199.30	1
FNR13475	4.3/4	\$214.00	1
FNR13500	5"	\$247.10	1
FNR13525	5.1/4	\$289.80	1
FNR13537	5.3/8	\$811.90	1
FNR13550	5.1/2	\$774.20	1
FNR13575	5.3/4	\$790.10	1
FNR13600	6"	\$1,161.10	1

CLAVE	DESCRIPCIÓN	PRECIO POR PIEZA	E
ANILLOS DE RETENCIÓN EXTERNOS			
FNR14025	1/4	\$3.17	100
FNR14027	0.276	\$4.22	100
FNR14028	9/32	\$2.50	100
FNR14031	5/16	\$2.56	100
FNR14034	11/32	\$2.62	100
FNR14035	0.354	\$2.77	100
FNR14037	3/8	\$2.69	100
FNR14039	0.394	\$2.75	100
FNR14040	13/32	\$2.80	100
FNR14043	7/16	\$2.80	100
FNR14046	15/32	\$2.86	100
FNR14050	1/2	\$2.93	100
FNR14055	0.551	\$3.55	100
FNR14056	9/16	\$3.54	100
FNR14059	19/32	\$3.67	100
FNR14062	5/8	\$4.01	100
FNR14066	43/64	\$3.98	100
FNR14068	11/16	\$4.04	100
FNR14075	3/4	\$4.08	100
FNR14078	25/32	\$4.21	100
FNR14081	13/16	\$4.21	100
FNR14087	7/8	\$5.61	100
FNR14093	15/16	\$5.86	100
FNR14098	63/64	\$6.23	100
FNR14100	1"	\$6.45	100
FNR14102	1.023	\$6.13	100
FNR14106	1.1/16	\$8.15	50
FNR14112	1.1/8	\$7.66	50

CLAVE	DESCRIPCIÓN	PRECIO POR PIEZA	E
ANILLOS DE RETENCIÓN EXTERNOS			
FNR14118	1.3/16	\$8.40	50
FNR14125	1.1/4	\$10.52	50
FNR14131	1.5/16	\$11.59	50
FNR14137	1.3/8	\$8.67	50
FNR14143	1.7/16	\$12.82	50
FNR14150	1.1/2	\$13.54	50
FNR14156	1.9/16	\$15.91	50
FNR14162	1.5/8	\$16.86	50
FNR14168	1.11/16	\$21.92	25
FNR14175	1.3/4	\$18.60	25
FNR14177	1.7/72	\$21.33	25
FNR14181	1.13/16	\$21.39	25
FNR14187	1.7/8	\$21.51	25
FNR14196	1.968	\$21.68	25
FNR14200	2"	\$22.01	25
FNR14206	2.1/16	\$35.48	20
FNR14212	2.1/8	\$34.99	20
FNR14215	2.5/32	\$34.99	20
FNR14225	2.1/4	\$35.56	20
FNR14231	2.5/16	\$41.53	20
FNR14237	2.3/8	\$38.57	20
FNR14250	2.1/2	\$42.56	20
FNR14275	2.3/4	\$89.00	5
FNR14300	3"	\$95.60	5
FNR14312	3.1/8	\$107.50	5
FNR14325	3.1/4	\$104.50	5
FNR14350	3.1/2	\$116.20	5
FNR14375	3.3/4	\$166.80	5
FNR14400	4"	\$205.50	1
FNR14425	4.1/4	\$263.90	1
FNR14437	4.3/8	\$419.20	1
FNR14450	4.1/2	\$321.50	1
FNR14475	4.3/4	\$498.50	1
FNR14500	5"	\$338.90	1

CLAVE	DESCRIPCIÓN	PRECIO POR PIEZA	E
ANILLOS DE RETENCIÓN EXTERNOS 			
FNR14525	5.1/4	\$652.00	1
FNR14550	5.1/2	\$1,736.00	1
FNR14575	5.3/4	\$2,478.50	1
FNR14600	6"	\$2,795.80	1

CLAVE	DESCRIPCIÓN	PRECIO POR PIEZA	E
ANILLOS DE RETENCIÓN TIPO E 			
FNR15006	1/16	\$1.03	100
FNR15009	3/32	\$1.16	100
FNR15011X	0.110	\$1.36	100
FNR15012	1/8	\$1.09	100
FNR15014	0.140	\$1.28	100
FNR15015	5/32	\$1.34	100
FNR15017X	0.172	\$1.41	100
FNR15018	3/16	\$1.47	100
FNR15021X	7/32	\$1.52	100
FNR15025	1/4	\$1.59	100
FNR15031X	5/16	\$1.71	100
FNR15037	3/8	\$2.19	100
FNR15043	7/16	\$2.37	100
FNR15050	1/2	\$2.99	100
FNR15062	5/8	\$4.38	100
FNR15074X	0.744	\$4.77	100
FNR15075	3/4	\$6.25	100
FNR15087	7/8	\$8.25	50
FNR15098X	0.984	\$9.35	50
FNR15118X	1.3/16	\$11.39	50
FNR15137X	1.3/8	\$17.26	25



CLAVE	NÚMERO DE PARTE	DIÁMETRO		E	PRECIO POR PIEZA
		MÍNIMO	MÁXIMO		

ABRAZADERAS LIBERTY

FAL4M	ML-4 Micro	1/4"	5/8"	10	\$9.80
FAL5M	ML-5 Micro	5/16"	3/4"	10	\$9.80
FAL6M	ML-6 Micro	1/2"	7/8"	10	\$9.80
FAL06	L-6	1/2"	7/8"	10	\$17.00
FAL08	L-8	1/2"	1"	10	\$17.40
FAL10	L-10	1/2"	1-1/8"	10	\$17.70
FAL12	L-12	1/2"	1-1/4"	10	\$17.90
FAL16	L-16	3/4"	1-1/2"	10	\$19.40
FAL20	L-20	3/4"	1-3/4"	10	\$20.60
FAL24	L-24	1"	2"	10	\$21.30
FAL28	L-28	1-1/2"	2-1/4"	10	\$23.50
FAL32	L-32	1-9/16"	2-1/2"	10	\$23.60
FAL36	L-36	2"	2-3/4"	10	\$25.00

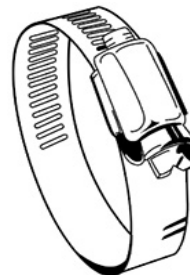

Banda: Acero inoxidable
Carcasa: Acero al carbón tratado con resistencia a la corrosión
Tornillo: Acero al carbón. Dicromatizado
Micro: Banda de 5/16"
Regular: Banda de 1/2"

ABRAZADERAS HS

FAH4M	HS-4 Micro	1/4"	5/8"	10	\$14.10
FAH5M	HS-5 Micro	5/16"	3/4"	10	\$14.10
FAH6M	HS-6 Micro	1/2"	7/8"	10	\$14.10
FAH06	MS-6	1/2"	7/8"	10	\$23.50
FAH08	HS-8	1/2"	1"	10	\$24.30
FAH10	HS-10	1/2"	1-1/8"	10	\$24.30
FAH12	HS-12	1/2"	1-1/4"	10	\$24.80
FAH16	HS-16	3/4"	1-1/2"	10	\$25.70
FAH20	HS-20	3/4"	1-3/4"	10	\$26.30
FAH24	HS-24	1"	2"	10	\$26.80
FAH28	HS-28	1-1/2"	2-1/4"	10	\$29.00
FAH32	HS-32	1-9/16"	2-1/2"	10	\$32.70
FAH36	HS-36	2"	2-3/4"	10	\$35.00
FAH40	HS-40	2-1/4"	3"	10	\$42.10
FAH44	HS-44	2-1/2"	3-1/4"	10	\$45.90
FAH48	HS-48	2-3/4"	3-1/2"	10	\$45.90
FAH52	HS-52	3"	3-3/4"	10	\$48.50
FAH60	HS-60	3-1/2"	4-1/4"	10	\$56.30
FAH72	HS-72	4"	5"	10	\$57.30
FAH88	HS-88	5"	6"	10	\$67.10
FAH96	HS-96	5-1/2"	6-1/2"	10	\$70.10
FAH104	HS-104	6"	7"	10	\$78.10

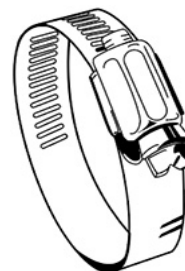

Banda: Acero inoxidable AISI 201
 1/2" de ancho, alta resistencia, ensamblada, no soldada ni remachada
Carcasa: Acero inoxidable AISI 201
Tornillo: Acero al carbón
Micro: Banda de 5/16"
Regular: Banda de 1/2"



CLAVE	NÚMERO DE PARTE	DIÁMETRO		E	PRECIO POR PIEZA
		MÍNIMO	MÁXIMO		

ABRAZADERAS TB PARA TRABAJO PESADO

FAT138	TB-138	1-3/8"	1-9/16"	1	\$198.90
FAT150	TB-150	1-1/2"	1-11/16"	1	\$201.20
FAT200	TB-200	2"	2-5/16"	1	\$194.20
FAT250	TB-250	2-1/2"	2-13/16"	1	\$199.90
FAT275	TB-275	2-3/4"	3-1/16"	1	\$203.80
FAT300	TB-300	3"	3-5/16"	1	\$206.50
FAT325	TB-325	3-1/4"	3-9/16"	1	\$209.60
FAT350	TB-350	3-1/2"	3-13/16"	1	\$209.70
FAT400	TB-400	4"	4-5/16"	1	\$215.20
FAT450	TB-450	4-1/2"	4-13/16"	1	\$220.00

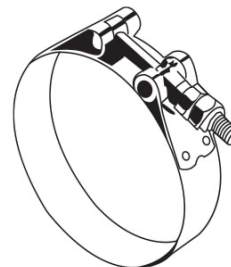

Banda: Acero inoxidable 300

Puente: Acero inoxidable 300

Perno: Acero al carbón

Tuerca: Acero al carbón con inserto de nylon

Buje: Acero al carbón

ABRAZADERAS TB PARA TRABAJO PESADO CON RESORTE

FAB225	TBS-225	2-1/4"	2-9/16"	1	\$234.70
FAB275	TBS-275	2-3/4"	3-1/16"	1	\$226.00
FAB300	TBS-300	3"	3-5/16"	1	\$236.80
FAB325	TBS-325	3-1/4"	3-9/16"	1	\$267.00
FAB350	TBS-350	3-1/2"	3-13/16"	1	\$240.20
FAB375	TBS-375	3-3/4"	4-1/16"	1	\$253.50
FAB400	TBS-400	4"	4-5/16"	1	\$255.70
FAB425	TBS-425	4-1/4"	4-9/16"	1	\$258.40
FAB450	TBS-450	4-1/2"	4-13/16"	1	\$258.40

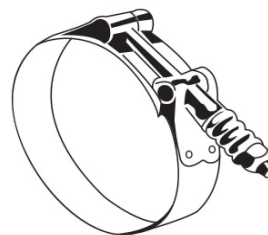

Banda: Acero inoxidable 300

Puente: Acero inoxidable 300

Perno: Acero al carbón

Tuerca: Acero al carbón con inserto de nylon

Buje: Acero al carbón

Resorte: Acero al carbón



CLAVE	NÚMERO DE PARTE	DIÁMETRO		E	PRECIO POR PIEZA
		MÍNIMO	MÁXIMO		

ABRAZADERAS PARA BOTA DE TRANSMISIÓN

FAM8	MS-8	1/2"	1"	10	\$19.10
FAM10	MS-10	1/2"	1-1/16"	10	\$19.10
FAM12	MS-12	1/2"	1-1/4"	10	\$19.10
FAM16	MS-16	3/4"	1-1/2"	10	\$19.10
FAM20	MS-20	3/4"	1-3/4"	10	\$20.50
FAM24	MS-24	1"	2"	10	\$21.30
FAM28	MS-28	1-1/2"	2-1/4"	10	\$22.00
FAM32	MS-32	1-9/16"	2-1/2"	10	\$22.70
FAM44	MS-44	2-1/2"	3-1/4"	10	\$37.40
FAM48	MS-48	2-3/4"	3-1/2"	10	\$39.40
FAM52	MS-52	3"	3-3/4"	10	\$39.60
FAM56	MS-56	3"	4"	10	\$39.60
FAM60	MS-60	3-1/2"	4-1/4"	10	\$40.80

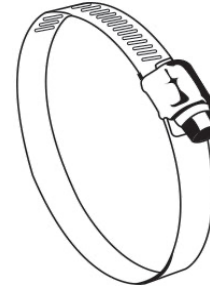

Banda: Acero inoxidable 301

Carcasa: Acero inoxidable 301

Tornillo: Acero al carbón dicromatizado

Banda regular: 1/2"

Banda micro: 5/16"